

Dustie

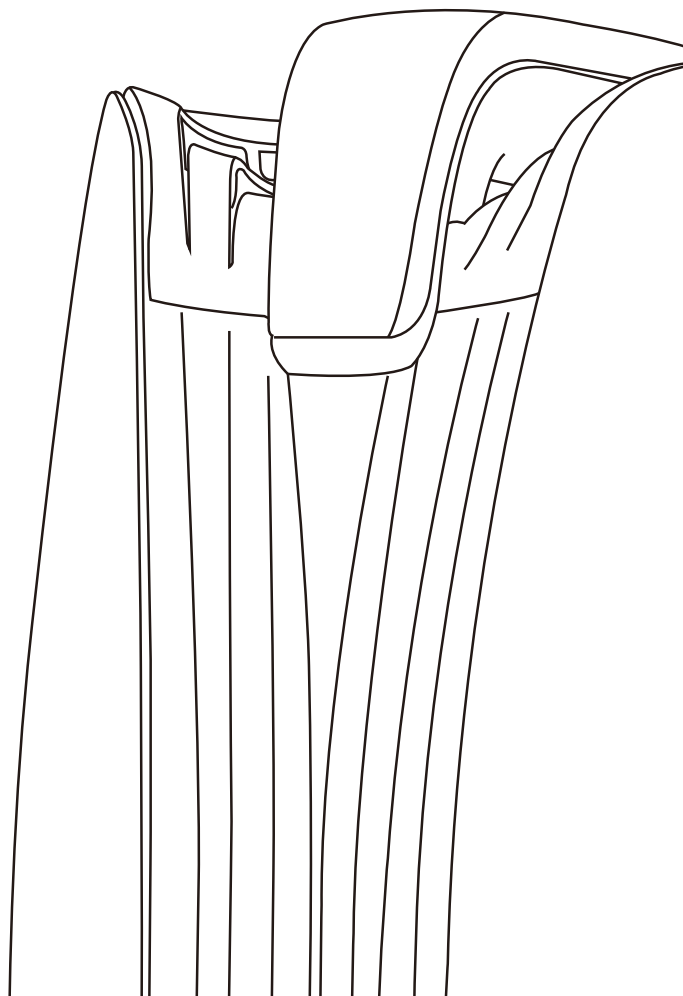

Dustie Air Cleaner 瑞典达氏空气净化器

DK1 Air Cleaner















Please read this operating manual,
Before using this product.

(请在使用本产品前，阅读本操作手册)

Safety Instructions

- Please read the operating manual carefully before use and keep it properly for future reference.
- This manual is applicable to the DK1 series models. Please operate according to the instructions of the purchased model.
- When using electrical appliances, we should have basic safety knowledge to avoid fires, electric shocks and other injuries. You are expected to follow the instructions below.

	Use the product safely to avoid fires, electric shocks and other injuries.		The product must be erect in operation.
	Do not lay the wire under a carpet or close to a heat source.		Keep foreign objects from entering or blocking the air inlet or outlet, otherwise the product will be damaged.
	When the filter replacement (cleaning) indicator is on, replace (or clean) the filter to ensure high cleaning performance.		Do not sit, stand or put items on the product.
	Do not use the product when it or its wire or plug is damaged.		Do not use the product in a place with any inflammable gas or steam.
	Do not use the product when it does not have a complete filter.		Do not use the product outdoors.
	Do not use the product close to a moist or easily wetted place, such as a bathroom, a kitchen, a water tank or a highly moist basement.		If the wire is damaged, have it replaced by the manufacturer or an authorized service center and maintenance personnel to avoid dangers.

【Preparation prior to use】

- Take out the product from its packing box and place it on a table or flat floor. The body of the product should be at least 60cm or more away from the walls or other home furnishing to promote air circulation.
- Please remove the left filter screen cover and pull out the plastic bag containing the HEPA and the activated carbon filter screens from the middle position in the upper part of the cover; restore the filter screens to the original positions in order and put on the cover.
- Prevent children or people who do not understand this product from using it.
- You can start to use the air cleaner and enjoy the fresh air.

Caution: Please remove all packing materials before use so as not to block the air inlet and outlet.

Names and specifications of parts

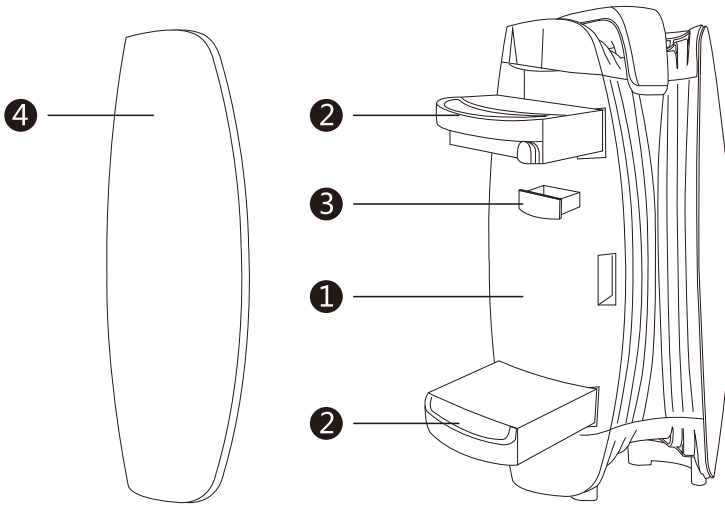

Caution  Only open the filter screen cover on the left side when replacing the filter screen.

- 1** Air cleaner body
- 2** EPA activated carbon filter screen set
- 3** Aromatherapy box
- 4** Filter screen side cover

Product	Dustie Air Cleaner	Mode of dust collection	Bidirectional vortex circulation and filtration system
Model	DK1	CADR of particular matters	110m ³ /h(*Note 1)
Rated voltage	220V ~ /50Hz	Particle energy efficiency	Qualified level (* Note 2)
Input power	30W	Applicable area (m ²)	8-13m ² (*Note 3)
Dimensions	179 (W) X222 (D) X424 (H) mm	Weight	2.9kg

*Note 1: Section 6.1.1 of the implementation standard GB/T 18801-2015
 *Note 2: Section 5.5.2 of the implementation standard GB/T 18801-2015





*Note 3: According to the relevant provisions of GB/T 18801-2015, the applicable area is equal to (0.07-0.12×CADR)

*Note 4: Section 5.6 of the implementation standard GB/T 18801-2015

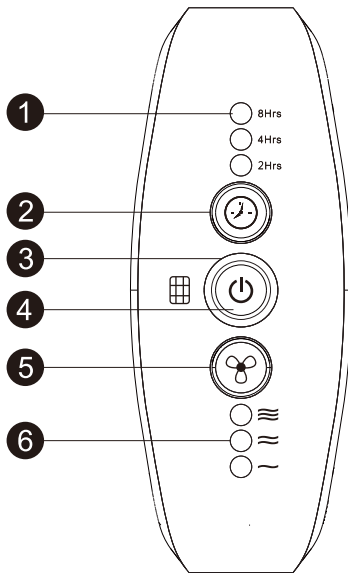
*Note 5: The product complies with standards GB 4706.1 and GB 4706.45-2008

Control panel



- 1 Timer indicator light 2Hrs 4Hrs 8Hrs
- 2 Timer button 
- 3 Filter screen replacement indicator power indicator (blue ring blink) 
- 4 Power button  (blue ring)
- 5 Air flow button 
- 6 Air flow indicator  light

Instructions

Insert the plug of the product into the standard 220V socket.



Please be sure to remove the plastic bag from the filter screen when the product is used for the first time!





Power-on

Press (). The blue power indicator light is lit. The product will power on. It will start with the Medium gear and run at the Low gear. The Low gear indicator light (green) is lit.

Power-off



Press () during operation to power off the product.

Air flow selection

Press () to switch to a medium or high air flow gear. There are three circular options of air flow, including Low, Medium and High. The green flow indicator light , , or  will be lit accordingly to indicate the selected gear.

Timer setup

Running time of the product can be set as 2 hours, 4 hours or 8 hours.

If () is pressed, the running time will be set as 2 hours and (2Hrs) the red indicator will be on. To switch to a running time of 4 or 8 hours, press () again. After that, the corresponding indicator (4Hrs or 8Hrs) will be on.

When none of these indicator lights is on, it suggests continuous operation.

Operation instructions

PS: Take out the side cover according to the instructions shown in the figure below.
EPA+ activated carbon filter screen:

The DK1 device has two groups of EPA filter screens which, coupled with the activated carbon, can remove the dust and haze in the air and all kinds of odor. Continuous use of the product can maintain the high quality air environment. Please be sure to remove the plastic bags from the two sets of filter screens.

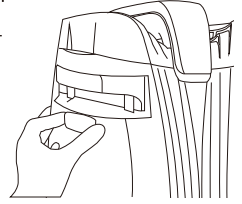

Aromatherapy function:

DK1 also has the aromatherapy function. Users can choose the fragrance of flowers according to their personal preferences to relax themselves. They can pull out the aroma and drop a few drops of their favorite aromatic compounds onto the sponge in the aromatherapy box. In this way they can not only enjoy fresh air, but also fragrant smell.

Replace the filter screen:

When the air cleaner is used for a total of 6,000 hours (equivalent to about 8 months of continuous use), the blue ring replacement monitoring light will blink continuously to remind you to replace the filter screen. At this point, please immediately replace the filter screen to maintain the air purification efficiency of the air cleaner. After the filter screen is replaced, press and hold the (⏻) button for 3 seconds. The blue ring indicator light is lit and the timer is reset. If the product is used in a place with poor air quality, it is suggested to shorten the interval of filter replacements to ensure normal filtering performance for the product.

Caution: The activated carbon filter screen should be frequently replaced according to actual needs. It's suggested that it should be replaced every three months.

When the blue ring indicator light continuously blinks, please replace the filter screen according to the following instructions:

The DK1 device has two groups of EPA filter screens which, coupled with the activated carbon, can remove the dust and haze in the air and all kinds of odor. Continuous use of the product can maintain the high quality air environment.

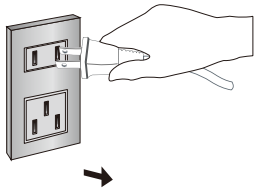

1 Stop and unplug the product.

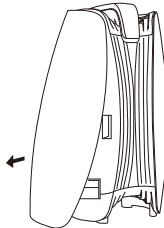

2 Remove the filter screen cover on the left side of the product and pull out the filter screen from the middle position in the lower part of the cover.

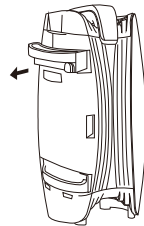

3 Pull out and remove the filter screen drawer

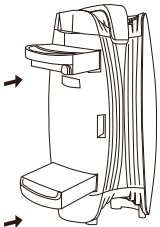

4 Replace and install the filter screen

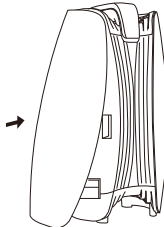

5 Restore the filter screen on the left side: hang the upper part of the filter screen and then lightly tug in and fasten the lower part.

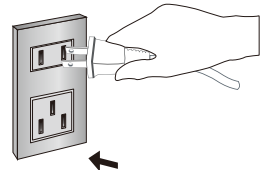

6 Insert the plug: Press (⏻) button to power on the product. Press and hold (⏻) button for about 3 seconds until the blinking indicator light no longer blinks. Timer has been reset. There will be a prompt upon the next setting time.

Common problems

Common problem	Troubleshooting
<p>Why is there no air coming out of the air cleaner?</p>	<ul style="list-style-type: none"> ● Inspect whether plastic bag of the filter has been removed or not. ● Inspect whether the filter has been properly assembled or not. ● Check whether the outlet in the upper part of the air cleaner is blocked. ● If it is blocked, it will affect the operation of the air cleaner. ● Inspect whether operation is set as the fixed-time mode and the set time is up.
<p>Why does the filter need to be cleaned?</p>	<ul style="list-style-type: none"> ● The filter is the core of the product, so regular cleaning can not only improve its filtering performance but also prolong its life. The DK1 series air cleaners can be externally cleaned after it is used for a period of time. After cleaning the filter screen according to the instructions, put it back into the air cleaner. Plug in the air cleaner.
<p>How often should the Clinic EPA screen be replaced?</p>	<ul style="list-style-type: none"> ● It depends on the service conditions. If the product is used in a place with poor air quality or in a newly decorated house, it is suggested to clean or replace the filter more frequently, so as to realize the best filtering efficiency. The DK1 series air cleaners have built-in timer. After the filter screen in the air cleaner is used for a time approaching the replacement limit, the replacement indicator light will blink to remind you to replace the filter screen. After cleaning the filter screen according to the instructions, put it back into the air cleaner. Plug in the air cleaner. Press and hold the corresponding filter (reset button) for 3 seconds to reset the timer.
<p>Why will the airflow be reduced after the air cleaner is used for a period of time?</p>	<ul style="list-style-type: none"> ● Make sure the air inlet and outlet are not plugged. Remove all the plastic bags from the filter screens. Check the condition of the filter screens and clean them if necessary. If the EPA screen is used for a period of time, consider replacing it. Make sure the air inlet grille is at least 30 to 90 centimeters away from the walls.

- If you need services or want to purchase filters and other supplies, please call our customer service line 4009-21-3058.
- Notes: The CCM of particular matters is obtained through the test with the specific smoke particles as the target pollutants in the laboratory conditions and identified according to the specified evaluation interval.
- Notes: The CCM of gaseous pollutants is obtained through the test with single gaseous pollutants as the target pollutants in the laboratory conditions and identified according to the specified evaluation interval.

安全重要提示

- 使用前请仔细阅读本操作说明指示，并妥善保管，以供日后参考。
- 本说明书适用于 DK1 系列型号，请依所购买机型操作。
- 当我们在使用电器用品时，应具备最基本的安全常识，以避免火灾、触电以及其他伤害的发生。因此，请遵守以下指示

	使用电器用品应注意避免火灾，电击和伤害的危险。		本空气净化器必须直立使用。
	请勿将电线安置在地毯下或者接近热源。		请勿让物体进入或阻挡进出风口，如此会损伤到空气净化器。
	更换（清洁）滤网检测灯亮起时就要更换（清洁）耗材，以确保空气净化器的清净效果。		请勿坐、站或放置物品在空气净化器上面。
	电线，插头或产品已破坏时请勿使用。		在有易燃的气体或蒸汽处，请勿使用空气净化器。
	除非滤网组件完备否则请勿使用。		请勿在室外使用。
	请勿将本产品靠近潮湿或容易被水泼湿的地方使用如浴室，厨房，水槽边及严重潮湿的地下室。		若电源线损坏时，必须由製造厂商或其授权服务网点及维修人员加以更换以避免危险。

【使用前准备工作】

- 将空气净化器从包装盒中取出，置于桌面或平坦地板上。机体离墙壁或其他家居至少 60 公分以上,利于空气循环。
- 请由机器左侧滤网盖下方中间位置往外侧拉出，取下包装HEPA与活性炭滤网的塑胶袋，并妥适依序将滤网安装回放置滤网位置，盖上滤网盖。
- 避免儿童或不了解本产品的人使用。
- 您可以开始使用空气净化器，畅享新鲜空气。

注意: 使用前请移开所有包装材料以免堵住进出风口。

部品名称及规格

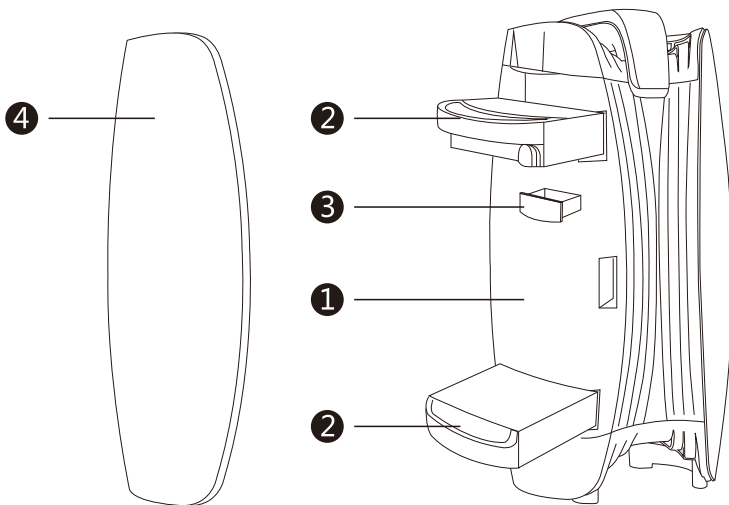

注意

更换滤网只需打开左
滤网侧盖

- ① 空气净化器本体
- ② EPA活性炭滤网组
- ③ 香薰盒
- ④ 滤网侧盖

产 品	Dustie 达氏 空气净化器	集尘模式	双向涡流循环过滤系统
型 号	DK1	颗粒物CADR	110m ³ /h (*注1)
额定电压	220V~ /50Hz	颗粒物能效	合格级 (*注2)
输入功率	30W	适用面积 (m ²)	8-13m ² (*注3)
尺 寸	179(宽)X222(深)X424(高) mm	重 量	2.9kg

* 注1：执行标准GB/T 18801-2015之6.6.1

* 注2：执行标准GB/T 18801-2015之5.5.2

* 注3：根据GB/T 18801-2015相关条款





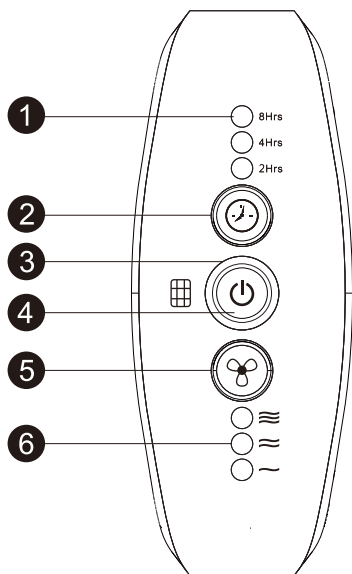

适用面积等于 (0.07-0.12*CADR)

* 注4：执行标准GB/T 18801-2015之5.6

* 注5：产品符合GB 4706.1、GB 4706.45—2008

控制面板



- 1 定时指示灯 2Hrs 4Hrs 8Hrs
- 2 定时按键 
- 3 更换滤网指示灯电源指示灯  (环状蓝色闪烁)
- 4 电源按键 (蓝色环状) 
- 5 风量按键 
- 6 风量指示灯   

使用说明

请将空气净化器插头插入标准 220V 插座。



注意

首次使用，请务必将滤网外塑料袋拆除！





开启电源

按一下()，蓝色电源指示灯亮起，空气净化器将开机中档启动后并于低档运行，低档风量指示灯(绿色)亮起。

关机



在空气净化器启动运转中，按一下()关机。

风量选择

要更换中档或高档，可按()来选择，风量大小以低，中，高方式循环。绿色风量指示灯 , , 或  相应亮起以指示选择档位。

定时设定

空气净化器可设定定时操作，分别为2，4，8小时。

按一下()，空气净化器将运转时间设定于2小时且(2Hrs)红色指示灯亮起。要更换4小时或8小时，可再按()，定时指示灯(4Hrs或8Hrs)亮起以指示选择时间。

若定时指示灯全部没有亮，则为连续运转。

PS：取下侧盖请参考下方图示

EPA+活性炭滤网：

DK1 装置有上下两组高效率EPA滤网 搭配活性炭除异味滤网 充分改善空气中尘霾 与各种异味的困扰，持续使用可以维持高品质的空气环境。首次使用请务必拆除上下两套滤网组塑胶袋。

香薰功能：

DK1 还贴心提供室内芳香功能，可依个人喜好选择各种清新花香，舒缓压力。把(Aroma)盒子取出来，滴几滴喜好的芳香剂在香薰盒子裡面的泡棉上，即可在净化空气的同时，享受清新芳香的气味。



更换滤网：

当本空气净化器累计使用达 6000小时(连续使用约8个半月)时，蓝色环状的更换监测灯将会持续闪烁，提醒您更换滤网。此时请即更换滤网，以维持净化器清洁空气的效能，更换完成后按压(⏻)键3秒环状蓝色灯恒亮，重新设定计时。如果使用在空气品质不佳的环境，建议您缩短更换滤网时间，以保持空气净化器功效。

说明:活性炭滤网请依实际需要,勤于更换,一般建议三个月更换一次。

当蓝色环状指示灯持续闪烁时,请依照下列说明更换滤网:

DK1 装置有上下两组高效率EPA滤网,搭配活性炭除异味滤网.充分改善空气中尘霾,与各种异味的困扰,持续使用可以维持高品质的空气环境。

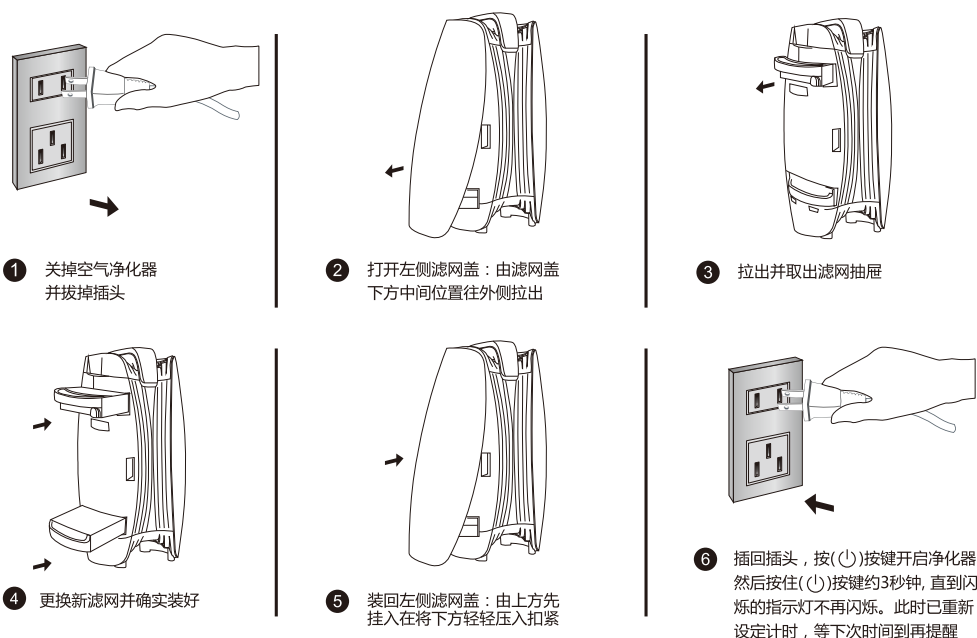

常见问题

常见故障	常见原因
为什么空气净化器没有出风？	<ul style="list-style-type: none"> ● 请检查电源线插头是否适当插好。 ● 请检查净化器滤网的塑胶袋是否拆除。 ● 请检查净化器滤网是否放置妥当。 ● 是否有物品堵住净化器上方出风口，如果出风口被堵住，会影响净化器运作。 ● 是否有设定定时运转，而设定时间已到。
为什么要清洁滤网？	<ul style="list-style-type: none"> ● 滤网是净化器的核心，定期的清洁滤网不仅可以提高滤材的过滤效果，还可以延长滤网的使用寿命。DK1系列滤网使用一段时间以后可进行一次外部清洁。请依照说明书指示清洁滤网后，放回净化器内，插上插头。
每隔多少时间该更换Clinic EPA滤网？	<ul style="list-style-type: none"> ● 根据用户的使用环境，如果环境空气品质较差，或是用于新屋装修后，建议较频繁的清洁滤网或是提早更换新的滤网，来保持最佳净化效能。DK1系列内置使用计时，机内各滤网使用时间达到需更换界限后，更换指示灯将会闪烁来提醒您更换滤网。请依照说明书指示清洁滤网后，放回净化器内，插上插头，按住Power按键（复归按键）3秒，以重新设定时。
为什么净化器使用一段时间后产生的气流会减少？	<ul style="list-style-type: none"> ● 确保空气入口和过滤后空气排出口没有被堵塞。取下过滤网中所有的塑料袋。检查过滤网的状况，如有必要，清洁过滤网。滤网如果使用一段时间，请考虑更换新的EPA滤网。确保空气入口格栅离墙壁的距离至少为30至90厘米。

- 如需要服务或购买过滤器等耗材，请联络顾客服务专线 4009-21-3058。
- 注：对于颗粒物CCM的标注，是在实验室条件下，以特定的烟尘颗粒物为目标污染物测试得出的，并依规定的评价区间标注。
- 注：对于气态污染物CCM的标注，是在实验室条件下，以单一的气态污染物为目标污染物测试得出的，并依规定的评价区间标注。

Consumer Warranty Card

消费者保修卡

Name 姓名				
Gender 性别	<input type="checkbox"/> Male 男士	<input type="checkbox"/> Female 女士	Mobile 行动电话	
Address 住址				
E-mail 电子邮箱				
Product Name 产品名称	空气净化器		Model NO. 产品型号	DK1
Serial Number 产品序列号	<div style="border: 1px solid black; width: 100%; height: 50px; display: flex; align-items: center; justify-content: center;">Series Number</div>			
Date of Purchase 购买日期	Y 年	M 月	D 日	
Notes 备注				

保修说明：

在正确使用方式下，自购买日期起12个月内，如因制造商的瑕疵而发生故障则免费维修（不包含过滤器）。

- * 一切人为损坏、天灾、地震、不在保证范围内。
- * 产品保修期内，若需要维修，请拨打客户服务热线：4009-21-3058
- * 若超过保修期限，则需酌收维修检测费用。
- * 请妥善保存购机凭证，例如订购单、送货单等。

以下情况恕不保修：

- * 无保修卡及有效凭证。
- * 非本公司指定维修部维修而自行拆装修理引起的损坏。
- * 跌落或使用不当造成损坏。
- * 耗材类不在保修范围内。例如：过滤器、灯管和电池等。

在实施本公司保修标准过程中，我司保留以上条款的解释权。当您在接受或需要服务时有不明之处，请咨询我司客户服务热线。

*保修服务区域仅限中国国内。



Wechat Official Service